



# SORRENTO ROADS

*by 1000 Miglia*

SORRENTO ROADS BY 1000 MIGLIA 2024

Sorrento, from 4<sup>th</sup> March to 6<sup>th</sup> April 2024

SPECIAL RACE REGULATIONS

S.R.R.

**This draft of the Special Race Regulations together with its attached: Times and Distances Table – Route maps – Signage of controls - Table of coefficients – Table of scores for Time Trials - Table of scores for Average Trials, was sent to ACI SPORT for approval the 17<sup>th</sup> January 2024 and published on the organizer website on the 18<sup>th</sup> January 2024.**

ORGANISATION: 1000 Miglia S.r.l.

PROGRAMME

Programme before the competition week

Wednesday 18<sup>th</sup> January 2024

Date of publication of SRR

Website

Opening date for entries by invitation

Competition Secretary

Tuesday 5<sup>th</sup> March 2024 at 16:00

Closing Date for entries

Competition Secretary

by Monday 11<sup>th</sup> March 2024

Publication of list of Competitors and cars accepted

Website

(After this date, it will no longer be possible to replace competitors, crews and registered cars)

Programme for the competition Week

Check in, documental control and distribution of the race materials	Place	Sorrento, .....TBA.....
	Date	04/04/2024 time 17:00-20:00
Publication of the starting list	Place	Sorrento, .....TBA.....
	Date	04/04/2024 time by 22:00
Briefing of the Organizer and of the Clerk of the Course	Place	Sorrento, .....TBA.....
	Date	04/04/2024 time 22:00
Start Sorrento Roads	Place	Sorrento, .....TBA.....
	Date	05/04/2024 time 08:30
Arrival Sorrento Roads	Place	Sorrento, .....TBA.....
	Date	05/04/2024 time 16:30
Entry in the Parc Fermé of “3° Trofeo Città di Sorrento” with straight single-elimination	Place	Sorrento, .....TBA.....
	Date	06/04/2024 time 16:00-16:30
Briefing with the Clerk of the Course of the “3° Trofeo Città di Sorrento”	Place	Sorrento, .....TBA.....
	Date	06/04/2024 time 16:30
Start of “3° Trofeo Città di Sorrento” with straight single-elimination	Place	Sorrento, .....TBA.....
	Date	06/04/2024 time 17:00
Closing of “3° Trofeo Città di Sorrento” with straight single-elimination	Place	Sorrento, .....TBA.....
	Date	06/04/2024 time 19:00
Posting of the Final Classification	Place	Official Notice Board - Website
	Date	06/04/2024 time 21:00
Prize Giving and dinner	Place	Sorrento, .....TBA.....
	Date	06/04/2024 time from 21:00

## Sorrento Roads by 1000 Miglia 2024 | Special Race Regulations

Competition Headquarters and Competition Secretary	Place Sorrento, .....TBA..... Date 04/04/2024 time 16:00-22:00 Date 05/04/2024 time 08:00-19:00 Date 06/04/2024 time 09:00-20:00
Official Notice Board	App Sportity - Password: SRMM2024
Website	<a href="https://1000miglia.it/en/">https://1000miglia.it/en/</a>

---

Synchronization of the Organisation's time-keeping systems: UTC (GPS) signal | Italia: GMT+1

---

### INTERPRETATION

All the times states in these SRR are understood as referring to the Time Zone in use in Italy, namely "Greenwich Mean Time + 1 hour" conventionally UTC (GPS) signal | Italia: GMT+1

The acronym "ASN" stands for National Sport Authority (ACI Sport).

Value Added Tax (VAT) will be applied on all amounts stated in these SRR at a rate of 22% (updated to 17.01.2024). Any variation on this percentage will be notified in the Bulletin and will be enforced in compliance with the laws issued by Italy.

# Sorrento Roads by 1000 Miglia 2024 | Special Race Regulations

## Article 1 - ORGANISATION

This event will be run in compliance with the International Sport Code (and relevant appendixes, where applicable), with the National Sport Regulations (and relevant appendixes where applicable) and with other provisions of the ACI Sport, which are understood to regulate whatever is not indicated in the following articles.

The Organiser states that the competition will have all the necessary administrative authorisations and the required insurance coverage.

## ART. 2 - OFFICIALS

Clerk of the course: Mr. Lucio DE MORI licence 20623

“Giudice Unico” Mr. Antonio MILO (ACI Sport Delegate) licence 56918

Sporting secretary of the event Mr. Paolo TOMASELLI licence 212269

Competitor Relations Officers \_\_\_\_\_ licence \_\_\_\_\_

Scrutineers:  
\_\_\_\_\_  
\_\_\_\_\_  
\_\_\_\_\_ licence \_\_\_\_\_  
licence \_\_\_\_\_  
licence \_\_\_\_\_

Technical Scrutineers: Mr. Paolo TOMASELLI licence 212269

Marshals: of the Automobile Clubs of Napoli, Brescia

Time keeping Service: F.I.C.R. (Federazione Italiana Cronometristi)  
Head of Timing Service: \_\_\_\_\_ licence \_\_\_\_\_  
Results: \_\_\_\_\_ licence \_\_\_\_\_

Press Officer: \_\_\_\_\_

TO ALL LEGAL EFFECTS, THE ITALIAN VERSION OF THESE SRR WILL BE BINDING. THE ENGLISH TRANSLATION OF THE SAME IS UNDERSTOOD AS BEING SOLELY FOR INFORMATION PURPOSES.

### Article 3 - RACE

The Organiser 1000 MIGLIA SRL holder of the licence n. 356540, announces and organises, on 4<sup>th</sup>-6<sup>th</sup> April 2024, a Touristic Regularity Competition for Modern and Historic Cars to be known as:

## SORRENTO ROADS BY 1000 MIGLIA 2024

The race belongs to zone 3.

The race will be held over 2 days.

### Article 4 - COMPETITORS, DRIVERS AND CARS ALLOWED

#### 4.1 COMPETITORS AND DRIVERS ALLOWED

4.1.1 Competitors, and crew members must hold a valid ACI Sport Competitor/Driver's Licence or a valid regularity licence turistica o superior (for Italian competitors/Drivers) or a valid Co-driver or Competitor/Driver's licence, issued by their ASN (for foreign competitors/drivers of International or National - with authorisation to compete in the event - level) valid in Italy.

4.1.2 At least one of the two crew members must be in possession of a valid driving licence during all the legs of the race.

4.1.3 Members of foreign crews not holding a valid Competitor's/Driver's licence issued by their ASN may, upon request of the interested parties, be issued with an ACI Sport tourist regularity licence valid only for the Sorrento Roads By 1000 Miglia 2024 race, and upon payment of the relevant fees.

4.1.4 A competitor who is a physical entity, entering a vehicle for the competition must always be on board the vehicle throughout the race.

4.1.5 During all the phases of the competition the vehicle may be driven only by crew members holding driving licences who have been verified and accepted with that specific vehicle.

4.1.6 Crew members below the age of 14 (i.e. those who have not yet turned 14 at the date of the end of the checks) and older than 84 years of age (i.e. those who will have already turned 85 as of 31.12.2023) will not be accepted.

4.1.7 Passengers will not be allowed, that is, crew members who have not been verified and who are not in possession of the requirements of Article 4.1.1, 4.1.2 and 4.1.6 of these SRR.

#### 4.2 ACCEPTED CARS

A maximum of 40 cars, modern or historic, with priority given to cars produced up to 1990, will be admitted to the competition.

The cars must also belong to the following classification periods:

A	built	from origins to 1904;
B	built	from 1905 to 1918;
C	built	from 1919 to 1930;
D	built	from 1931 to 1946;
E	built	from 1947 to 1961;
F	built	from 1962 to 1965;
G	built	from 1966 to 1971;
H	built	from 1972 to 1976;
I	built	from 1977 to 1981;
J1	built	from 1982 to 1985;
J2	built	from 1986 to 1990.

## Sorrento Roads by 1000 Miglia 2024 | Special Race Regulations

Each car must be included in each period based on the actual year of construction as noted on the registration certificate.

The cars allowed will be divided as follow:

- 1<sup>st</sup> Group: cars belonging to the Periods: A, B, C (built until 1930)
- 2<sup>nd</sup> Group: cars belonging to the Periods: D (built from 1931 to 1946)
- 3<sup>rd</sup> Group: cars belonging to the Periods: E, (built from 1947 to 1961)
- 4<sup>th</sup> Group: cars belonging to the Periods: F (built from 1962 to 1965)
- 5<sup>th</sup> Group: cars belonging to the Periods: G (built from 1966 to 1971)
- 6<sup>th</sup> Group: cars belonging to the Periods: H (built from 1972 to 1976)
- 7<sup>th</sup> Group: cars belonging to the Periods: I (built from 1977 to 1981)
- 8<sup>th</sup> Group: cars belonging to the Periods: J1 (built from 1982 to 1985)
- 9<sup>th</sup> Group: cars belonging to the Periods: J2 (built from 1986 to 1990)

4.2.1 To the above mentioned cars such documents (as Fiche Acisport, http FIA ect..) required in order to take part to Classic regularity races for historic cars are not requested. Plate test will not be allowed.

 20 modern cars

### 4.2.2 SELECTION OF REGISTERED CARS

The organizer will give priority to cars registered before 1990.

4.2.3 The cars entered must comply with the periodic revision of the vehicles if required and in accordance with the provisions of the laws of the country of registration. If the country of registration does not provide for the periodic revision of the cars, the competitor must produce a self-declaration in which he must declare the lack of need for revision according to the laws of the country of registration and consequently, he will declare to be able to circulate in his own country of origin having undergone all the technical checks to demonstrate the perfect efficiency of the car and all its devices. In the absence of this document the crew will not be able to pass the administrative controls.

### 4.4 RACE NUMBERS – ENTRY LIST

The assignment of the race numbers, also valid for the compilation of the Starting Order, made in compliance with the increasing order of the assigned numbers will respect, except for particular organizational needs, the criteria of the ascending order of the year of construction.

## Article 5 - ROUTE

The competition route will have an overall length of Km.148,50 and will be described in the Itinerary Table (TDT) attached to these SRR, and of which it is an integral part, and in the Road Book. The TDT will also show the methods of carrying out the timed Legs for classification.

The Sorrento Roads race foresees 15 Timed Trials (see art. 9.3), 3 Time Controls (see art. 9.2) and 1 Stamp check (see art. 9.4).

The start of the Sorrento Roads will be in Sorrento, .....TBD ..... starting at 8:30 on 05/04/2024; the arrival in Sorrento, ..... TBD ..... starting at 16:30 on 05/04/2024.

The race will take place on roads open to traffic, except for any limitations set out by the competent Authorities and/or Administrations, with average speeds not exceeding 50 Km/h

The route and procedure of the “3<sup>rd</sup> Trofeo Città di Sorrento” are described in Appendix 3 of these SRR.

### ART. 6 - ENTRIES

#### 6.1 METHOD OF PRESENTATION OF THE APPLICATION FORM

Entry applications may only be submitted via the Website [www.1000miglia.it](http://www.1000miglia.it).

The presentation date of each competitor's entry application coincides with the date on which the sum provided for in art. 6.3 below is credited to the bank account in the name of the Organiser. Entry must be formalized according to the days and times indicated in the Programme of these SRR.

Acceptance of the entry application accompanied by the payment of the entry fee and all the data necessary to complete the application in accordance with the terms and conditions set out in these SRR, will be announced to the Competitor by 11<sup>th</sup> March 2024.

6.2 The organisers will not be required to motivate the reason for exclusion, nor will they said exclusion allow for the request for damages and/or refund of expenses, excepting for the return of the deposit (Art. 6.3 of these SRR).

#### 6.3 ENTRY GUARANTEE DEPOSIT

6.3.1 Payment of Euro 3,660.00 (VAT included), valid as a deposit for entry of the car and team, must be made in one of the following ways:

- a) by Credit Card (only VISA - MASTERCARD) by 16:00 (GMT+1) on Tuesday 5<sup>th</sup> March 2024;
- b) by bank transfer to the coordinates indicated in the entry form, with maximum credit value on the 1000 Miglia S.r.l. current account by 16:00 (GMT+1) on Tuesday 5<sup>th</sup> March 2024.

#### 6.4 ACCEPTABILITY OF ENTRY REQUESTS

Entry requests must be complete with all the necessary documentation, also photographic, accompanied by the greatest number of documents attesting the history of the registered vehicle, and the payment of the deposit.

Failure to pay the deposit means the request for entry will not be taken into consideration.

Requests which are untrue, incomplete, without documentation or with amounts owing to the organisation, will not be taken into consideration.

The organisation reserves the right not to accept vehicles whose drivers have been penalised in previous editions of the "1000 Miglia".

The organizer also reserves the right not to accept the entry of drivers who for three times during the previous year's race committed infractions of exceeding the speed limit set by the authorities in charge and detected by the Speed Test prepared by the Management Race.

#### 6.5 ACCEPTANCE OF ENTRY

By Friday 11 March 2024, each team will be able to verify online, inside its own reserved area, whether or not the entry for the competition has been accepted. Confirmation will nonetheless be sent, according to the time limits mentioned above, also to the e-mail address indicated in the relative area of the entry form.

To complete entry, it will be necessary to enter the Bank details in the relative section of the on-line form, for the return of the fee, if necessary.

#### 6.6 FINALISING ENTRY

Entry is understood as being finalised only on acceptance of the entry request by the organiser and to the allocation of the sum paid as a deposit in the sum paid as an entry fee.

After the car has been accepted at the event, 1000 Miglia Srl will issue a regular invoice, using the data requested during the entry phase.

By presenting the request for entry, the applicant authorises the organiser to consider the amount paid previously as a deposit, as an entry fee in the case of acceptance of the request for entry.

**6.7. ENTRY FEE**

The Basic entry fee amounts to Euro 3,000.00 plus 22% VAT (total Euro 3,660.00) and includes:

- a) Participation in the competition after selection of the car:
  - kits of documents and technical materials required;
  - Welcome Bag;
  - Pass.
- b) Hospitality for a crew of two persons, including:
  - 3 nights in a double room in hotel (5 stars) IN 4<sup>th</sup> April OUT 7<sup>th</sup> April 2024;
  - 2 lunch per person;
  - 3 light dinner per person (one with Prize Ceremony).
- c) Services included in the entry:
  - Possibility to purchase additional service packages.

**6.8 REFUND OF THE ENTRY FEE FOR CREWS NOT ACCEPTED**

In the case of non-acceptance of a car by the organiser, the deposit will be refunded by bank transfer or accredited on the credit card, by Friday 29<sup>th</sup> March 2024.

**6.9 WITHDRAWAL OF AN ENTERED CAR**

In all cases:

- the request for withdrawal of the entry application, i.e. the entry, must be sent by e-mail to [participants@1000miglia.it](mailto:participants@1000miglia.it) with a request for acceptance by the recipient and followed by confirmation of receipt by the recipient himself. Competitors provided with certified e-mail (PEC) must send the abovementioned notice to the PEC address: [1000miglia@legalmail.it](mailto:1000miglia@legalmail.it);
- if due, the refund of the entry fees will take place within 60 (sixty) days following the announcement date of the withdrawal.

**6.10 REFUND OF THE ENTRY FEE IN CASE OF WITHDRAWAL OF THE ENTRY APPLICATION OR THE ACCEPTED ENTRY**

Except as otherwise provided in Article 6.12 below, in the event of withdrawal, for any reason, of the entry application or the accepted entry by a Competitor, the entry fees shall be refunded only as follows:

From: opening date for entries To: closing date for entries	The fee paid as deposit by the Competitor shall be entirely refunded to the latter, net of administrative charges in the amount of Euros 150.00 plus VAT equal to 22%;
From the day following the closing date for entries To: publication of list of Competitors and cars accepted	The fee paid as a deposit by the Competitor shall be entirely refunded to the latter, net of a penalty equal to Euro 500.00 (VAT exempt pursuant to article 15, paragraph 1, Italian Presidential Decree 633/72);
From the day following the publication of the list of Competitors and cars accepted To: Friday 29 <sup>th</sup> March	The entry fee shall be refunded to the extent of 50% plus VAT;
From: Saturday 30 <sup>th</sup> March	The entry fee shall not be refunded

**6.11 FAILURE TO PASS ADMINISTRATIVE CHECKS**

In the case of failure to pass the administrative checks and/or scrutineering, the competitor will not have the right to the refund of the entry fee paid, but will retain the right to make use of the hospitality envisaged for the team and any gifts and gadgets distributed directly by the sponsors, as per Article 6.7 of these SRR. This right shall be guaranteed only if the competitor or a crewmember with proxy signed by the competitor are present at the pre-competition administrative checks. Therefore, if Competitors or drivers authorised by the same, are not present at



the pre-competition checks, they will not be entitled to the refund of the entry fee, nor will they be allowed to enjoy the hospitality provided for the crew or any benefit or facilities reserved to the participants.

### 6.12 POSTPONEMENT OF THE EVENT DUE TO FORCE MAJEURE

The Organiser reserves the right, at any time and at its sole discretion, to postpone the Event if an extraordinary event qualifying as a Force Majeure circumstance occurs, or, for the occurrence of extraordinary and unforeseeable events, not dependent on its will, which may directly or indirectly influence the ordinary running of the event, such as, but not limited to, health emergencies, epidemics, pandemics, measures taken by the Public Authorities, earthquakes, landslides, floods or, in general, any other natural disaster that makes it impossible to hold all or part of the Event.

### 6.13 CANCELLATION OR SUSPENSION OF THE EVENT DUE TO FORCE MAJEURE

The Organiser reserves the right, at any time and at its sole discretion, to cancel and/or suspend the Event if an extraordinary event qualifying as a Force Majeure circumstance occurs, or, for the occurrence of extraordinary and unforeseeable events, beyond its control that may directly or indirectly influence the ordinary course of the event, such as, by way of example but without any limiting intent, health emergencies, epidemics, pandemics, measures by the Public Authorities, earthquakes, landslides, floods or, in general, any other natural calamity that makes it impossible to hold all or part of the Event.

In case of cancellation or suspension of the Race, the Organiser shall refund the entry fees as follows:

From: opening date for entries To: closing date for entries	The fee paid as a deposit by the Competitor shall be entirely refunded to the latter;
From the day following the closing date for entries To: Monday 11 <sup>th</sup> March	The fee paid as a deposit by the Competitor shall be entirely refunded to the latter net of a deduction as administrative and management costs equal to 20% of the fee paid plus VAT at 22%
From: Tuesday 12 <sup>th</sup> March To: Friday 29 <sup>th</sup> March	The entry fee shall be refunded to the extent of 50% plus VAT equal to 22%;
From: Saturday 30 <sup>th</sup> March	The entry fee shall not be refunded

In case of postponement of the race, the aforementioned time limits will be extended.

Competitors included in the Waiting List shall be subject to the provisions of Article 6.8.

## Article 7 - GENERAL OBLIGATIONS

### 7.1. PROCEDURE FOR PRE-RACE CHECK-IN, ADMINISTRATIVE CHECKS AND DELIVERY OF MATERIALS

The procedures for carrying out the administrative checks may be totally or partially dematerialised according to the regulations prepared by the ASN and national or territorial government Bodies.

Competitors and drivers must be present in person and with the accepted car, failure to do so will imply the impossibility of passing the checks and therefore of participating in the race, in the ways and means established in the programme. The Sports Inspectors and Road Traffic Police will undertake the following checks and formalities:

- a) checking of mandatory documents for competitors and drivers to be presented in original copy:
- valid driving license, national and international;
  - sports licence of the nation of belonging or Italian daily licence, the latter for foreign crews only;
  - medical certificate (not foreseen for the holders of a tourist regularity navigator licence)
  - valid competition car insurance;
  - competition car registration papers;
  - written authorization from competitor's N.S.A. if this does not belong to the EU / if this was not included in the registration form.
  - possible declaration of non-necessity of periodic revision of the vehicle according to the laws of the country

of registration of the vehicle.

- b) hand out and apply the Personal Identification Device (CPI) described in Article 7.2 of these SRR;
- c) acknowledgement of the briefing by the organiser and the Clerk of the course.

### 7.2 PERSONAL IDENTIFICATION DEVICE (CPI)

During the administrative checks, a Personal Identification Device (CPI) will be handed out to each driver, in order to identify clearly the participant for the entire duration of the event.

The staff delegated by the organiser will be responsible for the application of this device and this cannot be refused by the driver.

The device cannot be ceded and cannot be removed until the end of the competition on penalty of exclusion from the race.

The exhibition of the (CPI) can be requested by Officials or by escorting Road Traffic Police, at any moment. The absence of the sticker can result in the exclusion of the crew and the car from the race.

In the case of breakage or loss of the (CPI) the driver must first notify it to the first Competitor Relations Officer he finds along the route.

- 7.2.1 Only members of crews who have passed the pre-competition administrative checks can participate in the competition. No exchanges of authorised drivers are allowed between cars in the race.

Should persons other than those who have passed the pre-competition administrative checks be found on board a competition car during the race, except for the transport of an injured person, the car and its driver will immediately be excluded from the race; this also does not exclude further penalties to be decided at the discretion of the Stewards.

### 7.3 COMPETITION NUMBER STICKERS

At the administrative checks, each competitor will receive a Sticker Kit consisting of:

- 3 round number holder stickers, with the competition number and the Organizer's advertising;
- 2 series of pre-spaced fluorescent competition numbers.

#### 7.3.1 APPLYING THE COMPETITION STICKERS TO THE CARS

Cars must be presented for technical checks with all the kit stickers mentioned in Article 7.3 of these SRR already applied, according to the following instructions:

- a) 1 round number holder sticker for each side of the competition car on the front doors (in cars with doors) or on the front sides (on cars without doors or with small doors);
- b) 1 round number holder sticker on the front bonnet of the competition car;
- c) 1 pre-spaced fluorescent number on the front windshield positioned to allow it to be seen when looking at the front part of the competition car;
- d) 1 pre-spaced fluorescent number on the rear window: should this not be possible the sticker must be applied on the rear boot in such a way as to allow it to be visible looking at the back of the competition car;

The guide layout is provided attached to these SRR, for the correct positioning of the competition numbers (Appendix 3).

Should it not be possible to apply all three of the round number holder stickers that are distributed, on the cars due to lack of space, it will be possible to apply only 2 stickers. In this case, the third sticker must be returned to the Organisation at the technical check, failure to do so could result in exclusion from the race.

### 7.4 SCRUTINEERING

After having passed all the administrative checks, the crews must submit the cars to scrutineering, in the ways and times stated in the programme. Failure to do so will lead to the cars being excluded from the race. Checks will be as follows:

- a) check of the correct positioning of the stickers in compliance with Articles 7.3. and 7.3.1 of these SRR;

### 7.5 OBLIGATIONS OF COMPETITORS – RULES OF CONDUCT

Throughout the event, drivers must drive prudently and carefully, scrupulously respect the Italian Road Traffic Law and instructions given by the Clerk of the course and by Officials.

The Officials - those in Charge (Article 2 of these SRR) positioned in the Technical Support convoy (teams in the Front Car, Pace Car and Technical Car), Road Traffic Police Officers will notify violations and offences of the Regulations, and the Instructions stated above.

In the case of infringements, the CoC will notify the “Giudice Unico” who will apply the following penalties:

- first offence: 1.000 penalty points;
- second offence: 12.000 penalty points.

Depending on the seriousness of the offence, the “Giudice Unico” will apply the penalties up to exclusion from the event, even after only one offense.

In each Leg, the CoC can undertake speed checks on all the cars in the race.

The Officials along the route as well as all the cars in the Technical Support convoy (Article 2 of these SRR, teams in the Front Car, Pace Car and Technical Car) and Road Traffic Police Officers will also be responsible for supervising the conduct of the competitors and their service and team vehicles, notifying the Clerk of the course of any offence but without taking any independent decisions.

Also Road Traffic Police Officers and local Police Members in the relative areas can notify the CoC of any offences by competitors and their service and team vehicles.

Driving behaviour should always be prudent for oneself, for Officials, and especially for spectators.

Each competitor is always responsible also for the behaviour of their service and team vehicles, which must necessarily strictly observe the instructions given by Officials and Marshals and must follow the route envisaged in the Road book in some parts of the competition route. Failure to comply with this provision will result in sanctions against the relevant competitor, and may even lead to expulsion from the race, at the “Giudice Unico’s” discretion.

## Article 8 – REGROUPING

Not foreseen.

## Article 9 – RUNNING OF THE COMPETITION – MAXIMUM LATENESS

### 9.1 START

The cars will leave one at a time, from a stationary position with the engine running, one car departing every minute. Each car, once they have been given the “go”, will have to free the Departure area as quickly as possible.

Under the control of Officials, departure may take place by pushing the car, if it fails to leave on its own.

Competitors must not stop the competition car in the control areas (between the areas signalling the Start and End areas), exception being made for the check areas where the authorisation stamp will be printed by the Officials, reversing, changing direction, opening doors and in any way hindering the other teams will lead to the application of the penalty as stated in Appendix 4 of these SRR.

Drivers must keep to the Official Times stated in the Itinerary Table. No restrictions will be imposed on them as regards the use of time recording equipment. The same may be synchronized with the clock placed at the start of each Leg, without direct connection to the said clock.

Any defect in detection of times, caused by any failure or malfunction of the equipment, will result, for the said checks, in the application of the average to each competitor and/or the annulment of the checks themselves for all competitors.

The organisers will state in the Road book, this will also be indicated on site, a straight stretch of road with measurements, used as the measured base in the preparation of the Road book, and competitors can verify this before the race.

### 9.2 TIME CONTROLS (CO/TC)

The purpose of the Time Control (CO/TC) is to outline the areas in which the route of the competition is divided, in order to regulate the conduct of the same and to make sure the average speed is respected.

Each competitor must be measured on the minute (e.g. for transit time 14:01 it will be possible to transit without penalty from 14:01:00 to 14:01:59).

The excesses as regards the ideal times established will determine the classification.

Penalties for delays and early arrivals at a CO/TC are those stated in Appendix 4 of these SRR.

Delays and early arrivals at a CO/TC must not be caught up in the next CO/TC. Teams must leave the “check area” free for transit. They are authorised to enter this area on board their car, in the minute preceding the ideal one for transit, and remain in the area for the time strictly necessary to record the transit time.

When the time is being read, the car must be inside the time reading area. During reading operations, at least one member of the team must be on board the competition car.

The time used for the reading operation is not neutralised in any way. The reading is taken at the moment in which one member of the team hands over the Time Card to the Time-keeper.

In the case where competition cars that are late or in advance of their ideal times transit through the CO/TC in the minute pertaining to cars on time, the Time-keeper will make a note, on the Time Card of the team that is late or in advance, of the real transit time, which corresponds to the start of the next sector, giving precedence, in the marking operations, to the team with the less delay on the ideal transit time.

All the CO/TCs will be appropriately marked with signs in compliance with the examples attached to these SRR (Appendix 5).

Vehicles transiting through an CO/TC in the opposite direction or a direction other than the one decided by the organiser will be excluded from the race.

### 9.3 TIME TRIALS (PC/TT)

Time Trials (PC/TT) are those timed areas of the route, between two consecutive readings where the drivers must keep to a set time indicated in the Itinerary Table and in the Time Card.

The PC/TT readings will be carried out with a pressure switch.

Readings will be done at 1/100th of a second without any tolerance. Differences in the ideal time will, as for the differences read at CO/TC, be used in determining the classification.

PC/TT will be undertaken with departure read at free entrance; the driver will be able to choose freely the start of the PC, nonetheless within approx. 5 seconds from the “all clear” given by the Marshals and/or the Timekeeper in charge.

Various consecutive PC/TTs will be envisaged (interconnected), where the time for passing to the final reading of the previous PC/TT will be the start time of the next PC/TT, and so forth.

For PC/TT located in equipped areas or temporary circuits, competition tracks, kart-racing tracks, and for PC/TTs with lengths less than 300m, an appropriate map will be attached with the Road Book.

All PC/TTs will be properly marked both at the start and at the end, with signs in compliance with the examples attached to these SRR (Appendix 5).

In the area of the route between the yellow sign and the beige sign showing the start and end of the measuring area, cars are not allowed to park, stop or open the doors. Should any cars stop in this measuring area due to a breakdown, they must be immediately removed according to the instructions given by the competition official, on penalty of exclusion.

In the stretch of route between the yellow sign at the beginning and the beige sign at the end of the reading area, access is also forbidden to the drivers and navigators who arrive in the control area before their transit time.

No complaint is allowed for any obstacles, difficulties or impediments that may occur in the distance covered during the PC/TT: each competitor must overcome them with their own means and abilities, while respecting the rules of the Highway Code of the countries crossed.

In the case of absence of a reading by a competitor, or even the absence of a result by one or more PC/TT, irrespective of the reason for this, the competitor will always be assigned a time relating to the missing PC/TT as resulting from the average PC/TT actually clocked by the said competitor in the Laps where the PC/TT are missing. The request will be made at the end of the Lap under consideration.

### 9.4 PASSAGE CONTROLS (CT/PC)

The purpose of the Passage Controls (CT/PC) is to check the strict adherence to the established route.

The opening and closing times of the CT/PC will be notified by the Clerk of the course Bulletin. At the CT/PCs, drivers must stop the cars in order for the check stamp or “all clear” stamp to be printed in the relative area of the Time Card. The absence of this stamp will mean exclusion.

All the CT/PC areas will be properly marked with signs in compliance with the examples attached to these SRR (Appendix 5).

Vehicles transiting through a CT/PC area in the opposite direction or one other than the one decided by the Organiser will be excluded from the race.

### 9.5 MAXIMUM LATENESS

A crew will be over the maximum lateness:

- if it transits through a Time Control (CO/TC) with more than 15 minutes delay.
- if it accumulates delays through various Time Controls totalling more than 30 minutes delay.

The opening and closing times of the Time Trials (PC/TT) and of the Print Checks (CT /CP) will be notified through a Clerk of the course Bulletin.

## Article 10 – ARRIVAL

Arrival check of Sorrento Roads by 1000 Miglia will be in Salerno, TBD and will be open from 15:30 of 05/04/2024.

## Article 11 - CLASSIFICATION - PROTESTS AND APPEALS

### 11.1 CLASSIFICATION

The following classifications will be drawn up:

- a. Overall;

- b. Group;
- c. Female crews (both members female);

### 11.2 COMPILATION AND PUBLICATION OF RESULTS

The classifications will be drawn up based on the penalties incurred by each crew in the PC/TT and in the PM/AT, in the CO/TC and calculated based on the coefficient assigned to each car added to any penalties listed in art. 16.

The coefficient assigned to each car is calculated by applying the following criterion: taking the year of manufacture of the car indicated on the sports documents of the car itself, the number of hundreds is removed and a comma is inserted in its place.

(Eg.: production year 1939 Coeff.: 1,39 Penalty hypothesis: 500 points Score:  $500 \times 1,39 = 695$ ) (Eg.: production year 2005 Coeff.: 2,05 Penalty hypothesis: 500 points Score:  $500 \times 2,05 = 1,025$ )

The final sum of all the penalties obtained by each competitor is then multiplied by the assigned coefficient.

The crew that obtains the lowest number of penalties, multiplied by the relative coefficient, will be declared the winner.

In case of ties in the final classification, the best finish will be assigned to the crew with the best result net of the coefficient, in case of further ties, the best finish will be assigned to the crew with the oldest car, in case of further ties, the best finish will be attributed to the crew with the best placement in the first 10 PC/TT carried out on Thursday, net of the coefficient.

### 11.3 PROTESTS AND APPEALS

Protests and appeals must be submitted in the manner and within the terms established by the National Sporting Regulations.

- For each protest, the security deposit is € 350,00.
- For each appeal, the security deposit is € 3.000,00.

#### 11.3.1 TERMS FOR SUBMISSION OF PROTESTS OR REQUESTS OF TIME CHECK

Competitors may submit a complaint (including a request of timing verification) against published documents, within 30 minutes of their publication on the Competition Notice Board, notifying the Competition Secretariat in writing of the reasons for the dispute.

## Article 12 - PRIZES

### 12.1 HONOUR PRIZES

The event will have the following honour prizes:

- |  |                              |
|--|------------------------------|
| - for the first 5 crews of the overall classification:         | prizes for both crew members |
| - for the first classified of the Group classification:        | prizes for both crew members |
| - for the first classified of the female crews classification: | prizes for both crew members |

The rankings will be drawn up without any difference on the penalties accumulated in the race and in accordance with Article 13 RDS Regularity. The prizes of the general classification, group and priority drivers are not cumulative; therefore, the winners of more classifications will be awarded only the prize of the most relevant classification.

### 12.2 ADMISSION TO COPPA DELLE ALPI 2024

The following Competitors will be guaranteed acceptance at the "Coppa delle Alpi 2025" event, subject to compliance of the car with the SRR of the Competition:

- to the first entrant classified in the "Overall" Classification;

## Sorrento Roads by 1000 Miglia 2024 | Special Race Regulations

The prizes that will give the right to participate in the Coppa delle Alpi 2025 edition will be given to the physical or legal subject to whom the invoice for the entry fee of the Sorrento Roads 2024 by 1000 Miglia Srl will be registered. The aforementioned subject's right to inform 1000 Miglia of a different subject that will acquire this right remains firm. Such request for modification must be sent via email to [participants@1000miglia.it](mailto:participants@1000miglia.it) on or before 12.04.2024. In any case, participation will be subject to the payment of the fee indicated in the Supplementary Race Regulations and will be guaranteed only to those cars which are eligible under the aforementioned Regulation.

### Article 13 - GENERAL RULES

#### 13.1 RESPONSIBILITIES

By the very act of entering for this event, each competitor declares for themselves and their drivers, for the staff on their own service vehicles and accompanying vehicles, for their dependents and assignees:

- to recognize and accept the provisions of the National Sporting Regulations (and Sector Rules) and the present SRR, committing themselves to respect and to enforce them;
- to undertake to settle any dispute that may arise due to facts deriving from the Organisation and from the running of the event, by means of the mechanisms and methods of settlement set up by ACI, renouncing to appeal to any authority other than the sporting authorities for the protection of his rights and interests and those of his drivers, co-drivers, employees and appointees;
- to relieve the Italian Automobile Club, the ACI Sport, the ACI Brescia, the Organiser 1000 Miglia S.r.l. and all persons involved in the organisation, as well as the Automobile Clubs involved in the event, the Local Authorities involved, the Officials and the owners of the routes where the competition takes place from any liability regarding any damages to competitors, or their drivers, navigators, employees and agents, or things, or produced or caused to third parties or of objects by the competitor himself, his drivers, navigators, employees and agents.

Throughout the race, drivers must strictly comply with all the rules of the Highway Code and the instructions given by the Clerk of the Course and must drive conscientiously and prudently. They must not stop the car, reverse, drive in the opposite direction, open the doors or obstruct the other crews in any way in the control areas identified by the signs at the start and end of the control area.

Drivers and navigators must behave prudently for themselves, the Race Officials and in particular for the spectators. It is forbidden to lean out of the moving car. In the event of road obstructions or other cases of force majeure occurring before the start, the race route may be modified or some particular sections may be neutralized where the limitations of any average speed could lead to dangerous situations.

#### 13.2 DISPUTES

Competitors undertake to resolve any dispute of a patrimonial nature that may arise due to facts arising from the application and/or interpretation of these SRR and from the course of the Event by means of the sports arbitration provided for in articles 236 et seq. of the National Sporting Regulations and the ACI Sporting Justice Regulations for disputes of a sporting nature that occurred during the Event. All disputes of a technical and disciplinary nature definitively decided by the Organiser and/or its own bodies that have given rise to penalisation or exclusion from the Event rankings or to financial penalties are expressly excluded from the sporting arbitration.

#### 13.3 ADVERTISING

No form of advertisement may be placed on the car, unless this is expressly provided for by the organiser, which will be announced by a special information bulletin, in compliance with the provisions of current ACI Sport legislation.

The names of the crewmembers can be written on each of the sides of the competition cars in the maximum dimension of 10 x 40 cm per side.

## Sorrento Roads by 1000 Miglia 2024 | Special Race Regulations

A Club logo, not having advertising purpose (all or part thereof), can appear on each side of competition cars occupying a maximum space of 10 x 10 cm, per side or equivalent surface.

The original livery is tolerated as regards identification badges, even if they constitute advertising, limited however to what was originally used for that specific vehicle identified with the chassis number.

Any form of advertising that does not correspond to what is stated in this article will be removed by the Organiser and/or by Officials who will carry out checks before and during the race.

The breach of the provisions of this article will be sanctioned with 12,000 penalties. Those crews that will be found non-compliant with the provisions set forth above will be denied participation in future editions of the event. The organiser reserves the right to charge the offending crew with damages resulting from the contravention of this Article.

The participants therefore agree to assume the obligation to pay compensation for all damages suffered by the organiser and third parties in general, relieving the same from any liability, for any and all liability and/or damages resulting from the violation of the abovementioned prohibition.

### Article 14 - APPENDIXES

The following appendixes are an integral part of these SRR:

- APPENDIX 1: Itinerary Table (the definitive Itinerary Table will be communicated with the Road book);
- APPENDIX 2: Maps of the route
- APPENDIX 3: Regulatory appendix for 3° Trofeo Città di Sorrento and related Planimetry
- APPENDIX 4: Positioning of competition numbers on the cars;
- APPENDIX 5: Signage Posters of Checks

### Article 15 – INSURANCE

#### 15.1 INTRODUCTORY REMARKS

The entry fee includes the insurance premium for the competitors' civil liability to third parties for risks arising from circulation during the rally, along the route (fixed route and/or alternative) described in the Road book or in RG2 or given out by Bulletins and Clerk of the Course Communications.

#### 15.2 DAMAGES COVERED BY THE INSURANCE

The Insurance Policy of the Organiser is covering only the damages caused to third parties or properties of third parties by the Organiser or by drivers entered in the rally. Any other damage suffered by the drivers, co-drivers or vehicles entered in the rally are not covered by the insurance.

#### 15.3 ORGANISERS' RESPONSIBILITY

The Organiser decline liability for any accident suffered by competitors or competing cars during the duration of the entire event, even in case of cataclysm, riots, demonstrations, vandalism, etc. Competitors and crew members shall suffer all the consequences (material, criminal and sporting) raised by any type of accident.

#### 15.4 INSURANCE COVERAGE

The maximum amount covered by the Insurance Policy is € 25,000,000.00 for each accident for damages to persons and for damages to goods.

#### 15.5 DURATION OF THE INSURANCE COVERAGE

This insurance, for all competitors, will become effective at the start of procedure for car scrutineering. The insurance ceases at the end of the event or at the end of the event or, in case of withdrawal, disqualification or exclusion from the race, at the time taken into account will be the closing time of the following TC.



### 15.6 ACCIDENT NOTIFICATION

In case of an accident the competitor or his representative must immediately notify it to the Clerk of the Course. Place, circumstances under which the accident occurred, causes and consequences must be described. Likewise, the names and addresses of any witness or injured person must be indicated.

## Article 16 – PENALTIES AND DISCIPLINARY MEASURES

### 16.1 Time checks (CO/TC)

- For every minute or fraction thereof early: 100 penalties
- For every minute or fraction thereof late: 100 penalties with a maximum of 300
- For each delay beyond the maximum time: exclusion

### 16.2 Time Trials (PC/TT)

- For each 1/100 of second early or late: 1 penalty with a maximum of 300

### 16.5 Time Card

- Alterations, changes or corrections not endorsed by Officials: exclusion
- Failure to record a CO/TC: exclusion
- Lack of a control stamp (CT/PC): exclusion
- Failure to return to the CO/TC of Leg arrival: exclusion

### 16.6 Other Penalties

- refusal to start at the hour and in the set order: 100 penalties
- stopping the car in the control area (stationary wheel): 100 penalties
- unauthorised access of the crew in the check area (subject to further action): 300 penalties
- missing transit or time annotation at any control point: exclusion
- unauthorized stopping in a control area: exclusion
- blocking the passage and/or damaging other crews: exclusion
- for non-sportsmanlike behaviour: from warning to exclusion
- for passage in a control area in a wrong or different direction: exclusion
- for infringement of the Highway Code: up to exclusion
- for irregularities in documents during checks: no admission
- failure to comply with the checking times: up to exclusion
- for delay in departure more than 15 minutes: no admission
- allowing a person other than a crew member to drive the car: exclusion
- for non-prudent behaviour of a crew member, or assistants or team car: up to exclusion
- for leaning out of a moving car: up to exclusion
- for any specious or unjustified request to verify times: up to exclusion
- article 7.5 - first offense: 1.000 penalties
- article 7.5 - second offense: 12.000 penalties
- infringements of the rules on advertising on cars in the race: 12.000 penalties
- for irregularities of the car: up to exclusion

## Sorrento Roads by 1000 Miglia 2024 | Special Race Regulations

Supplementary Regulations of the touristic regularity race titled for “Sorrento Roads by 1000 Miglia 2024” of 4<sup>th</sup> - 6<sup>nd</sup> April 2024.

The LEGAL REPRESENTATIVE declares to have made changes to the particular regulation established by ACI-Sport.

The carrying out of the Race is in any case subject to the release of the authorization by the competent Ministry of Transport, General Directorate for Road Safety as provided for in paragraph 3 of art. 9 of the new Italian highway code.

These Special Competition Regulations/Organization Permit may be revoked at any time in the event of violation by the Organizer of the art. 56 of the National Sports Regulations recognized by the Federation

**The Clerk of the course**

(for having read and accepted the assignment)

signed: *Mr. Lucio DEMORI*

**The legal representative of the Organising Body**

signed: *Mr. Alberto PIANTONI*

**For the Regional Delegation**

signed: *Mr. Pasquale CILENTO*

SEEN AND THEREBY APPROVES

THE SECRETARY OF ACI SPORTS BODIES

\_\_\_\_\_

Approved on (date) \_\_\_\_\_ with approval number \_\_\_\_\_

APPENDIX 1

- Itinerary Table

*The official and final TDT will be available in the Road book*

APPENDIX 2

- Road Map

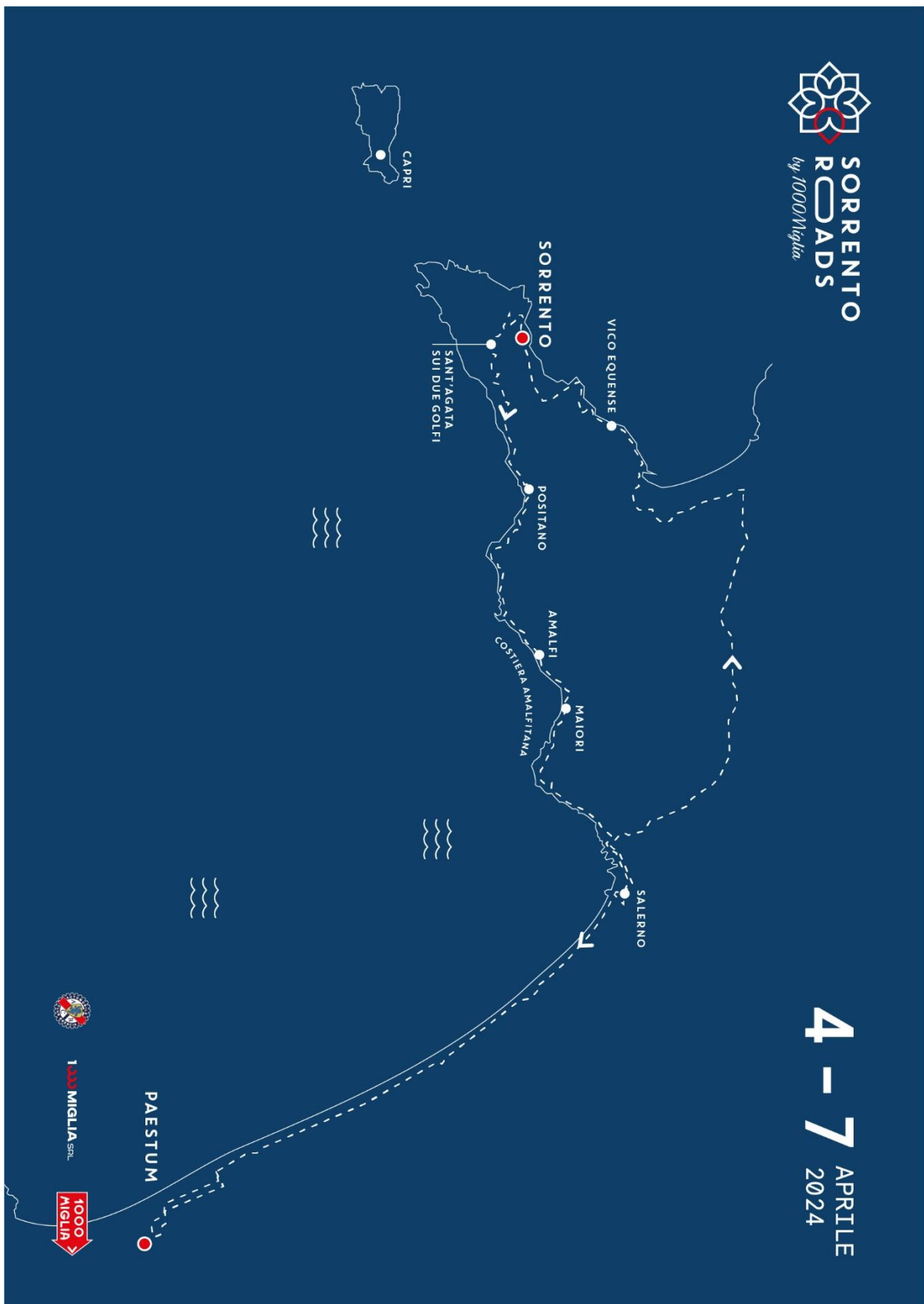

APPENDIX 3

REGULATORY APPENDIX "3° TROFEO CITTA' DI SORRENTO"

ART.1 – ELIGIBLE COMPETITORS AND DRIVERS

All competitors entered in the regularity tourist race "Sorrento Roads by 1000 Miglia 2024" will be able to take part in the REGULARITY TRIAL WITH DIRECT ELIMINATION, CARRIED OUT IN PARALLEL, called "3° TROFEO CITTA' DI SORRENTO" that will take place on Saturday 6<sup>th</sup> April 2024 in Sorrento according to the programme of the event "Sorrento Roads by 1000 Miglia 2024".

ART. 2 – ROUTE

The test will take place on a course set up on two parallel lanes with a length of 120 m. The time required to cover the course is 27 seconds with an average speed of 16 km/h. The race will take place in Corso Italia in Sorrento and with a liaison to Piazza Angelino Lauro, through others city roads.

ART. 3 – PROCEDURE, COMPOSITION OF THE RACE BOARD

Vehicles taking part in the Trofeo must report to the Parc Fermé in accordance with the times and places detailed in the programme in this SRR.

After entering the Parc Fermé, the Clerk of the Course will explain how the race will be carried out.

The 3° Trofeo Città di Sorrento will be held in three parts:

1) Step 1: QUALIFYING

In this preliminary phase, all drivers may carry out a maximum of two repetitions of the test. The times, to the hundredth of a second, will be recorded with the aid of a pressure switch at the start and end of the trial. The best scores realized by each Competitor will compose the classification which will be used to set the scoreboard of the next phases, the 1<sup>st</sup> classified against the 32<sup>nd</sup>, the 2<sup>nd</sup> against the 31<sup>st</sup> and so on. In case a challenge can't be competed for, the Competitor without opponent will be admitted to the next phase.

In case of joint winners, the admission to the next phase will be assigned to the oldest car as written in the list of crews authorised to start verified.

2) Step 2: ELIMINATION ROUNDS FROM THE 32-CREW SCOREBOARD

The crews will race against each other in parallel, as indicated in the scoreboard completed after the qualifying.

The crew with less penalties will access the next phase.

In case of joint winners, the admission to the next phase will be assigned to the oldest car as written in the list of crews authorised to start verified.

Starts will be given by means of a traffic light system, times will be recorded to the hundredth of a second, with pressure switches at the End of the Trial.

3) Step 3: FINAL TRIAL

The two qualified crews will race against each other in parallel in the best of three runs of the Trial. The starts will be given at by means of a traffic light system, the times will be recorded to the hundredth of a second, with pressure switches at the End of the Trial.

ART. 4 – TIMEKEEPING AND RANKINGS

Timekeeping will be carried out as follows:

## Sorrento Roads by 1000 Miglia 2024 | Special Race Regulations

- Time recording to one hundredth of a second.
- There are no coefficients.
- One penalty will be awarded for every hundredth of a second before or after the set time.

### 1) TIME RECORDING IN QUALIFYING

- The start and end time of the trial will be measured with a pressure switch;

### 2) TIME RECORDING IN HEAD TO HEAD ELIMINATION

- The time required to complete the trial starts when the green light comes on;
- The end time of the trial will be measured with a pressure switch.

A ranking of the best performances of each crew in the qualifying phase will be drawn up. There will be no final ranking. The winner of the "3<sup>rd</sup> Trofeo Città di Sorrento" will be the winner of the last knockout round on the scoreboard.

## ART. 5 – PRIZES

### 5.1 HONOUR AWARDS

The race will feature the following honour awards:

- For both members of the winning crew in the head-to-head elimination phase

### 5.2 ACCEPTANCE TO THE 2025 COPPA DELLE ALPI

The winner of the knockout phase will be guaranteed acceptance to the 2025 Coppa delle Alpi event, provided the car complies with the Special Race Regulations.

The award, which will entitle the participant to take part in the Coppa delle Alpi 2025, shall be granted to the physical or legal entity to which the invoice is made out for the entry fee paid for the Sorrento Roads by 1000 Miglia 2024. This is without prejudice to the right of the aforementioned subject to communicate to 1000 Miglia SrL by e-mail at [participants@1000miglia.it](mailto:participants@1000miglia.it) by 15.04.2024 a different subject who will acquire this right. In any case, participation shall be subject to the payment of the fee indicated in the SRR and shall be granted exclusively to cars eligible for participation in accordance with the provisions of the SRR.

## ART. 6 – 3° TROFEO CITTA' DI SORRENTO RACE TRACK

Look at the next page.



**SORRENTO  
ROADS**  
*by 1000Miglia*

**CHALLENGE 1 VS 1**  
**3<sup>rd</sup> CITTÀ DI SORRENTO TROPHY**  
**06 APRILE 2024**



DISCOVER MORE  
[1000miglia.it](https://1000miglia.it)



**1000MIGLIA** SRL



APPENDIX 4

- Positioning of Race Numbers on the cars

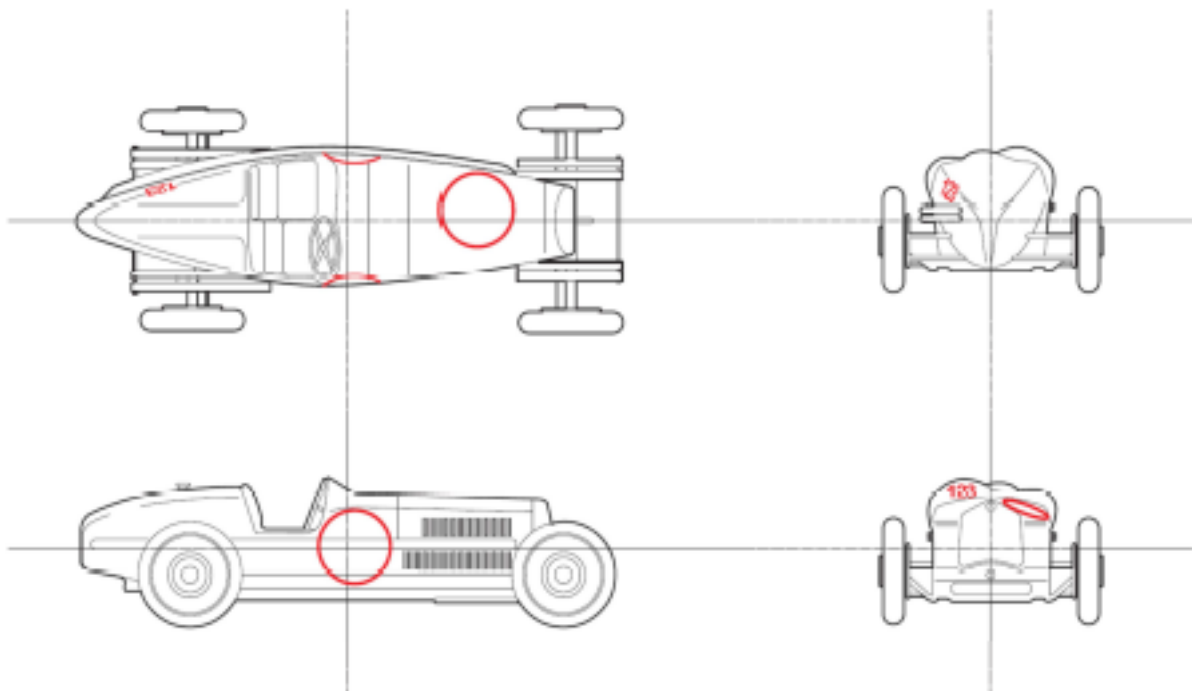
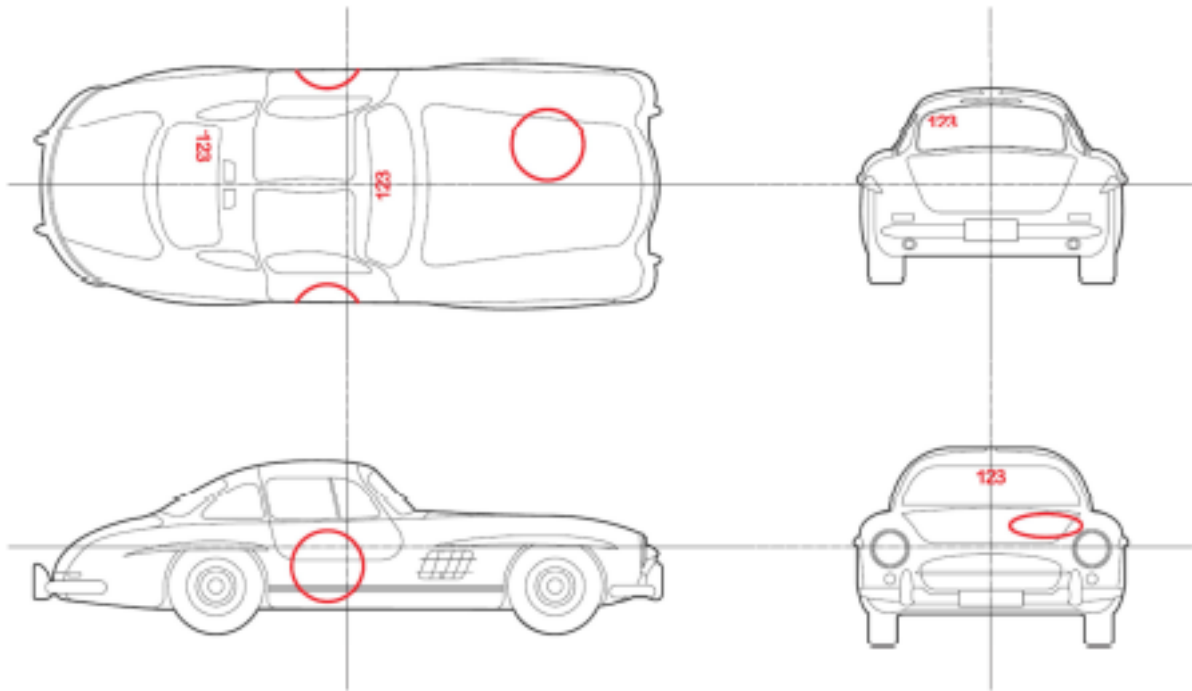













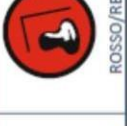



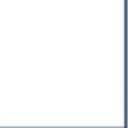











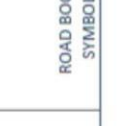

APPENDIX 5

- Control signs

CARTELLI DEI CONTROLLI - CONTROL SIGNS

	INIZIO ZONA CONTROLLO • CONTROL AREA START	CONTROLLO • CONTROL	FINE ZONA CONTROLLO • CONTROL AREA END	INIZIO ZONA CONTROLLO • CONTROL AREA START	CONTROLLO • CONTROL	FINE ZONA CONTROLLO • CONTROL AREA END
<b>CO / TC *</b>	 GIALLO/YELLOW mt 25 circa - approx.	 ROSSO/RED mt 25 circa - approx.	 BEIGE mt 25 circa - approx.	 GIALLO/YELLOW mt 25 circa - approx.	 ROSSO/RED mt 25 circa - approx.	 BEIGE mt 25 circa - approx.
	<b>CT / PC **</b>					
<b>PC ***</b> SINGOLE O CONCATENATE LUNGHEZZA INFERIORE / UGUALE A 300 MT.	 GIALLO/YELLOW mt 25 circa - approx.	 ROSSO/RED lunghezza inferiore/uguale - length inferior/equal to 300mt.	 BEIGE lunghezza inferiore/uguale - length inferior/equal to 300mt.	 GIALLO/YELLOW lunghezza inferiore/uguale - length inferior/equal to 300mt.	 ROSSO/RED mt 25 circa - approx.	 BEIGE mt 25 circa - approx.
<b>TT ***</b> SINGLE OR CONNECTED LENGTH INFERIOR / EQUAL TO 300 MT.	 GIALLO/YELLOW mt 25 circa - approx.	 ROSSO/RED mt 25 circa - approx.	 BEIGE mt 25 circa - approx.	 GIALLO/YELLOW mt 25 circa - approx.	 ROSSO/RED mt 25 circa - approx.	 BEIGE mt 25 circa - approx.
<b>PC ***</b> SINGOLE O CONCATENATE LUNGHEZZA SUPERIORE A 300 MT.	 GIALLO/YELLOW mt 25 circa - approx.	 ROSSO/RED mt 25 ca - approx.	 BEIGE mt 25 circa - approx.	 GIALLO/YELLOW mt 25 circa - approx.	 ROSSO/RED mt 25 circa - approx.	 BEIGE mt 25 circa - approx.
<b>TT ***</b> SINGLE OR CONNECTED LENGTH SUPERIOR TO 300 MT.	 GIALLO/YELLOW mt 25 circa - approx.	 ROSSO/RED estensione della prova di media / extension of average test				
<b>PM</b> PROVA DI MEDIA CON UNO O PIU' CONTROLLI SEGRETI	 GIALLO/YELLOW mt 25 circa - approx.	 ROSSO/RED				
<b>AT</b> AVERAGE TEST WITH ONE OR MORE SECRET CONTROLS						

**\*Ai Controlli Orari NON SEGUITI da Start Prova Cronometrata**

Le vetture sono autorizzate ad entrare nella zona di controllo (tra il cartello giallo e quello rosso di controllo) nel minuto che precede il loro minuto teorico di transito (solo se la zona è già stata liberata dalle vetture che precedono) oppure nel loro minuto teorico di transito e devono consegnare la tabella di marcia al cronometrista, per l'annotazione dell'orario di transito. I membri dell'equipaggio sono autorizzati a rimanere a bordo della vettura.

**\*\*Ai Controlli Timbro**

I membri dell'equipaggio devono rimanere a bordo della vettura e consegnare al commissario la tabella di marcia, per l'apposizione del timbro, senza iscrizione dell'orario di transito; la sosta nella zona deve essere limitata all'operazione di timbratura.

**\*\*\*Nelle Prove Cronometrate**

Tra il cartello giallo di inizio ed il cartello beige di fine zona controllo è vietato l'arresto (fermo vettura/fermo ruote) e la sosta della vettura.

**\*At the Time Controls NOT FOLLOWED by Start Time Trials**

The cars are authorized to enter the control area (between the yellow and red control sign) in the minute preceding their theoretical transit minute (only if the area has already been freed from the cars ahead) or during their theoretical transit minute and must hand in the time card to the timekeeper, in order for him to note down the transit time. Crew members are allowed to remain on board the car.

**\*\*During the Time Trials**

Between the yellow sign at the beginning and the beige sign at the end of the control area, it is forbidden to stop (vehicle stopped/wheels stopped) and park the car.

**\*\*\*At the Stamp Controls**

The crew members must remain on board the car and hand in the time card to the Marshal, where he will put the stamp, without inscription of the transit time; parking in the area must be limited only to the stamping operation.